

**Fasteners**  
**Product Catalog**

## Improving Quality and Lowering Costs Past, Present and Future

Shanghai Autocraft Co Ltd is a core automotive screw supplier to leading automotive OEMs in the world for the past 15 years. We are a licensed manufacturer of TAPTITE® and REMFORM® screws.

They are high performance, vibration resistant thread-rolling fasteners eliminating tapping and the need for secondary locking features, creating cost savings for industry.

Originally introduced in the late 1950s as a way to efficiently affix telecommunications equipment in the field, **TAPTITE® TRILOBULAR®**-shaped thread-forming fasteners are now embraced by the automotive, industrial, electronics, appliance, and countless other industries.

**TAPTITE®** fasteners form their own internal thread directly into the nut member, conforming perfectly to the TAPTITE® screw. This results in excellent grounding properties. Many of today's largest automotive OEMs, electric vehicle manufacturers and tier suppliers now use **TAPTITE PRO®** thread-forming fasteners in both grounding and general use joining applications.

**POWERLOK®** thread-locking fasteners provide mechanical resistance to vibrational loosening, eliminating the need for expensive physical and chemical locking solutions.

**REMFORM®** fasteners allow direct fastening into a wide range of modern plastics, eliminating the cost and weight of inserts.

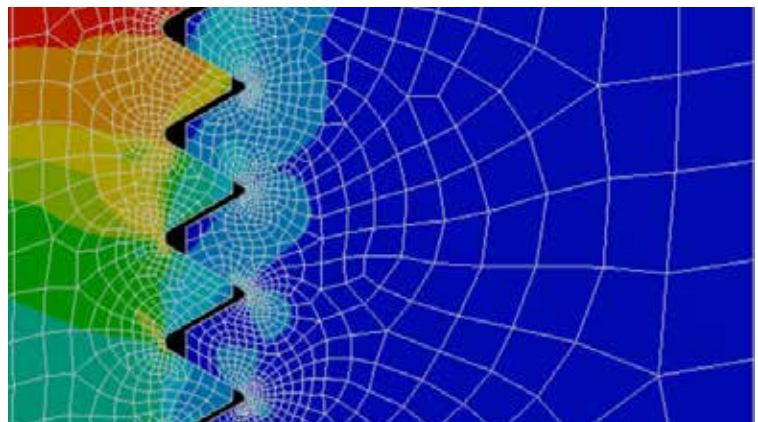



## Table of Contents

A Commitment to Quality.....	4
Why Choose Genuine Licensed Product?.....	5
A Primer on our Fasteners .....	6
<b>TAPTITE® THREAD-ROLLING SCREWS FOR METAL.....</b>	<b>9</b>
TAPTITE PRO® .....	11
TAPTITE PRO® SP™.....	13
TAPTITE PRO® CA™.....	14
TAPTITE PRO® NST™.....	14
FASTITE 2000®.....	16
TAPTITE 2000® (legacy).....	18
DUO-TAPTITE® (legacy).....	19
TAPTITE II® (legacy).....	19
TAPTITE® Cost Savings Breakdown.....	20
<b>POWERLOK® THREAD-LOCKING SCREWS FOR METAL.....</b>	<b>23</b>
POWERLOK® II™ .....	24
POWERLOK® (original).....	25
<b>REMFORD® THREAD-FORMING SCREWS FOR PLASTIC .....</b>	<b>27</b>
REMFORD® II™.....	28
REMFORD® II HS™.....	29
REMFORD® II FT™.....	29
REMFORD® (original) .....	29
<b>SPECIALTY TRILOBULAR® SCREWS .....</b>	<b>30</b>
<b>APPLICATIONS .....</b>	<b>33</b>
<b>A GLOBAL LICENSEE NETWORK .....</b>	<b>41</b>

# A Commitment to Quality

Seemingly low-tech components, such as fasteners, are sometimes an afterthought in the development of complex products. Whether because of the complexity of product development, rushed timelines or excessive reliance on accepted theoretical classifications, implementation of flawed strategies can mean fatal sourcing consequences. Despite being theoretically classified as non-critical, parts like fasteners can be critical on a system level and therefore have a large impact on profits.

This perspective on quality informs everything we do in support of our fastener licensees and end users. We provide detailed product specifications, technical resources and ongoing training and support for our licensees. The ability to source parts of consistent quality from a large universe of high-quality manufacturers globally.

solves problems and creates opportunities for manufacturers. Expanding into new geographies with a ready-made and trusted supplier base or expanding into a new application with support from both the fastener licensor and manufacturing licensees helps improve growth, profitability and returns on time and invested capital.

Shanghai Autocraft is a licensed manufacturer of the full line of Taptite® and Remform® screws.

# Why Choose Genuine Licensed Product?

PROCUREMENT OF LICENSED PRODUCTS IS OFTEN THE BEST SUPPLY CHAIN OPTION. BUT WHY?

When customers engage with licensors and licensees of licensed products, they can get support from both. The licensor wants to support end users regardless of which licensee gets the order. Licensees will compete to earn the customer's business by providing value beyond competitive pricing. Licensed products also have specific manufacturing and quality standards and licensors provide quality auditing of licensees. This provides an outside resource to consult / assist if quality or process issues arise that are potentially related to the licensed part. Licensors and licensees often provide end users with non-price value in the form of application engineering, technical assistance, training, quality assurance, inventory management solutions and other services and solutions not easily accounted for in the product price.

Forward-thinking manufacturers forge long-term relationships with licensees of products that improve quality and lower cost. These companies would presumably not have invested in the license and pay the ongoing royalty costs for products that do not uniquely add value. These licensees often understand the customer's business quite well and can provide value-added ideas directly and indirectly related to the products they sell. Since licensees of proven products tend to be more established companies, they often operate globally, have capabilities to produce standard products at many locations and present less risk as a supplier. This ability to source consistently high-quality parts globally saves both time and money.

## Copycat Parts A False Economy

There's always someone cheaper - but at what cost? Buying parts from copycat producers introduces lots of risk to the ultimate product manufacturer.

Some questions manufacturers should ask themselves before considering the use of copycat parts:

### Before I use a copycat part:

- How do I know if the parts are produced to specification? Who has the actual product specifications? Is there any specification at all?
- If I buy from multiple manufacturers, are they made the same way? Will they perform identically?
- Who do I turn to if they are not produced correctly?
- What recourse do I have if the quality is not acceptable?
- Who will be the arbiter if there is a dispute about product quality?
- In the context of a line shutdown caused by a copycat product, was the perceived savings worth it or did it represent a false economy?

Buying genuine licensed parts ensures lower risk and provides better value for manufacturers.



# A Primer on our Fasteners

## What are Thread-rolling Fasteners?

By definition, thread-rolling fasteners create their own mating threads as they are inserted into a blank hole. Unlike conventional machine screws, there is no need to tap threads in a hole before inserting a fastener. Thread-rolling screws entirely eliminate the tapping process and its associated cost and labor. The environmental impact of assembly is also reduced by elimination of tapping lubricants and subsequent solvent washing.

As thread-forming fasteners create their own threads, it is physically impossible for them to cross-thread in initial assembly. The thread-

forming process also work hardens the nut, and produces a “hand in glove” fit. The mating surfaces of fastener and nut are in full contact, minimizing the potential for vibrational loosening and maximizing the surface contact. For these reasons thread-forming fasteners are often chosen for grounding and electrical applications.

The **TAPTITE®** family of thread-rolling fasteners offers designs to satisfy the entire range of thread-forming applications.

### Conventional Machine Screw Process

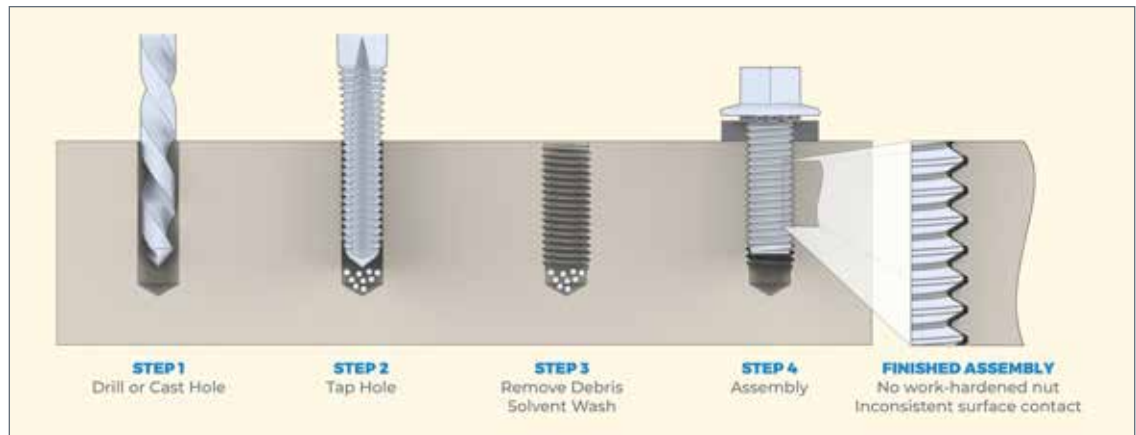

### TAPTITE® Thread-Forming Process

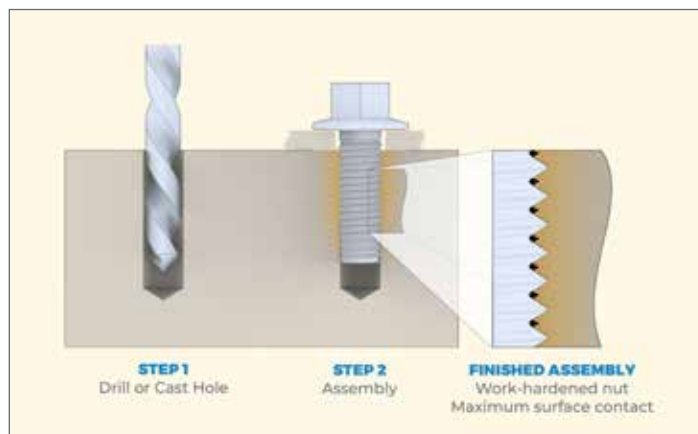

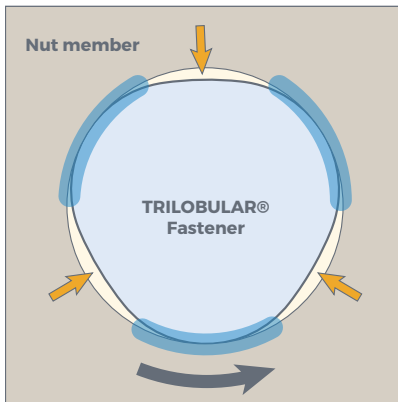

**TRILOBULAR® cross-section**  
(lobulation not to scale)

- Elastic rebound of nut member
- Reduced thread-forming torque

## Why a TRILOBULAR® shape body?

The **TRILOBULAR®** cross section provides several advantages over conventional machine screws when used in metals.

For thread-rolling screws, the **TRILOBULAR®** shape lowers thread-forming torque by reducing surface contact with the nut member.

The **TRILOBULAR®** cross-section creates vibration resistance in thread-rolling and thread-locking screws. The elastic properties of steel nut members cause the nut material to rebound slightly after fastener insertion. This metal backfills between the lobes of the TRILOBULAR® shape, providing a natural locking action and a correspondingly high prevailing torque without the need for adhesives, patches, springs or locking nuts. Prevailing torque is an indication of resistance to vibrational loosening.

## What are Mechanical Thread-locking Fasteners?

While many chemical adhesives and patches exist to lock fasteners in nut members, each adds significant cost and environmental considerations. Mechanical locking fasteners eliminate chemicals, using only part design optimizations to create locking interference with the nut member.

The **POWERLOK®** family of thread-locking fasteners employs a patented thread profile that mechanically interferes with the root of the nut member. This reliable design provides numerous

advantages over chemical locking solutions. The cost of chemicals and additional process is eliminated. Locking is instantaneous, unlike chemical solutions where adhesive curing time is required. **POWERLOK®** fastener performance is unaffected by temperature fluctuations, and works with all finishes. The locking performance of these fasteners is consistent along the length of the screw thread, not just in the small area containing a patch or adhesive placement.

## What about thread-forming in plastics and light alloy materials?

Since plastic generates less thread-forming resistance and is a viscoelastic material, a TRILOBULAR® cross section is not required. However, pull-out resistance, crack propagation, boss bursting and clamp load generation are more significant challenges when fastening plastic assemblies.

**REMFORM®** thread-forming screws for plastic are round-bodied fasteners with a proprietary asymmetric thread form. This thread form promotes efficient material displacement and material flow. This helps in thread-forming, generating clamp load, resistance to pullout and resistance to boss bursting.

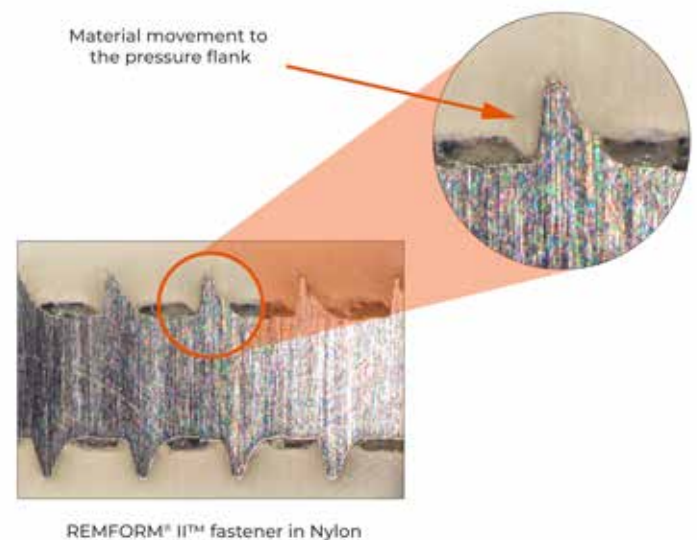

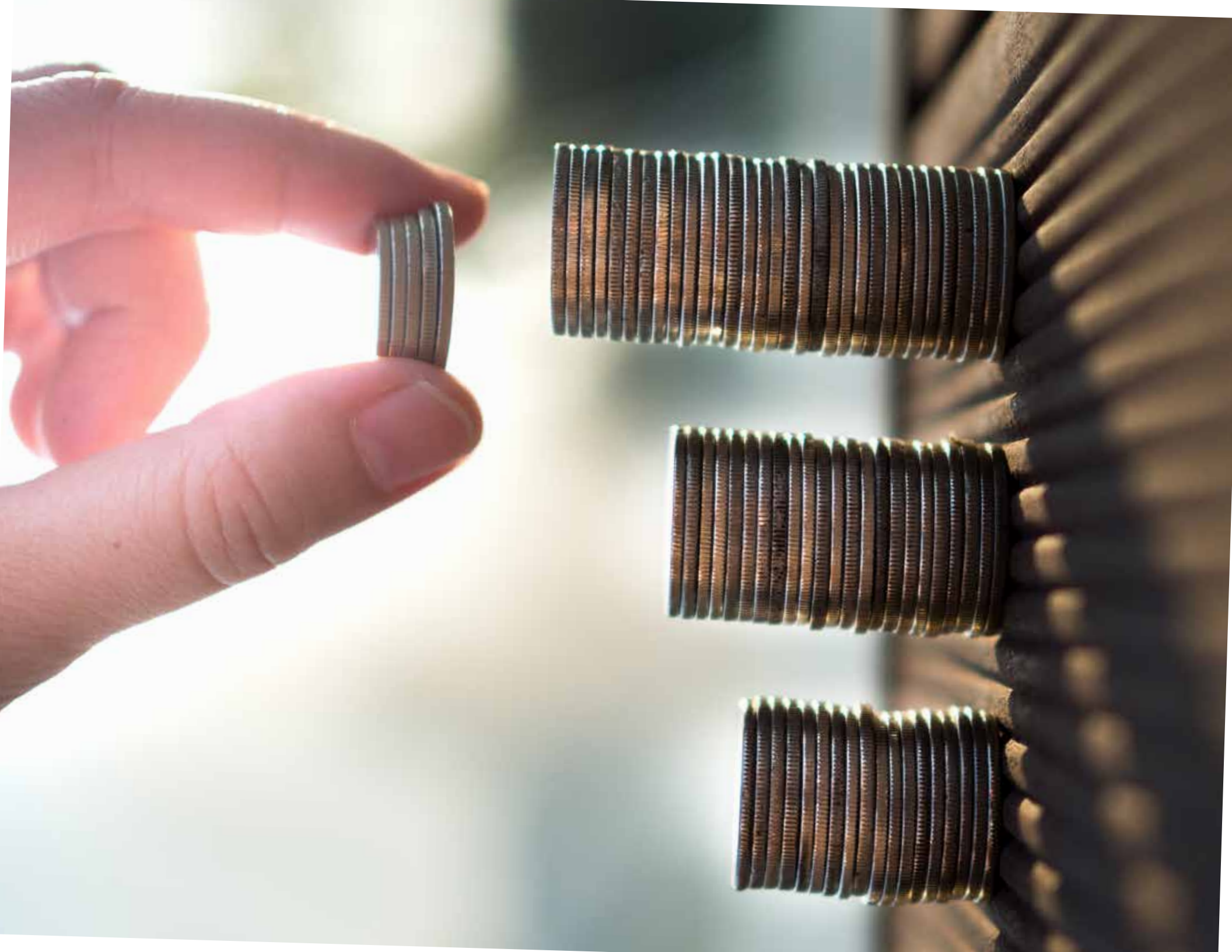





# TAPTITE<sup>®</sup>

## Thread-rolling Fasteners

For decades, **TAPTITE<sup>®</sup>** thread-forming screws have been the proven fastener solution for **LOWERING THE OVERALL COST OF ASSEMBLY**.

TAPTITE<sup>®</sup> fasteners combine industry leading performance with **remarkable cost savings** in production. As these fasteners form their own threads, they eliminate all the costs and overhead of

the tapping process. This perfectly mated connection between the screw and the formed internal threads also makes TAPTITE<sup>®</sup> screws an excellent choice for any grounding or electrical applications.

Consider how the TAPTITE<sup>®</sup> family of fasteners can create value in your operation:

### Part Cost Reduction

**TAPTITE<sup>®</sup>** fasteners are thread-rolling fasteners that form safe, high-quality joints without the need for:

- Nuts
- Lock washers
- Adhesives
- Patches

### Direct Labor Costs

**TAPTITE<sup>®</sup>** fasteners also help reduce the amount of direct labor needed in the fastening process by eliminating:

- Drilling
- Tapping
- Hand starting
- Cleaning
- Work-in-progress management
- Inspections of threaded holes
- Repairs in-line and off-line

### Indirect Labor Costs

**TAPTITE<sup>®</sup>** fasteners can also lower the amount of indirect labor associated with fastening by reducing:

- Part count / SKU Library
- Vendors
- Inventory management of fasteners and fastener tools
- Workers' compensation claims

### Capital Equipment Investment

**TAPTITE<sup>®</sup>** fasteners reduce capital equipment investment by eliminating or minimizing:

- Part storage costs / real estate costs – eliminate drilling and tapping stations
- Tapping equipment
- Cleaning equipment
- Inspection equipment
- Fixtures
- Gauges

### Process Costs

**TAPTITE<sup>®</sup>** fasteners reduce costs as the process is not burdened with:

- Maintenance and repair of drilling, tapping, cleaning and inspection equipment
- Removal of chemical lubricants used in tapping process
- Multiple part processes and associated opportunities for errors

### Environmental Costs

**TAPTITE<sup>®</sup>** fasteners eliminate the environmental concerns of:

- Tapping fluids
- Chemical lubricants used in the tapping process
- Contaminated cleaning fluids and solvents
- Energy required to operate tapping and cleaning equipment





Since before the industrial revolution, designers and manufacturers have chased two seemingly disparate goals – improving joint performance while lowering the overall cost of assembly. For over six decades, genuine **TAPTITE**® thread-forming fasteners have delivered this holy grail combination, blending optimum performance with genuine, quantifiable cost savings.

The newest member of the family in this storied legacy is the **TAPTITE PRO**® thread-forming fastener. Leveraging the latest advancements in thread-forming technology, **TAPTITE PRO**® fasteners offer even greater opportunity to save costs and ensure reliable performance in joint assembly.

---

## Parabolic Profile™ Thread Form

The innovative Parabolic Profile™ thread form, unique to **TAPTITE PRO**® fasteners, advances current thread-forming technology to the next level. This innovative new thread form provides the same low forming torque to reduce operator fatigue, maintains excellent resistance to vibrational loosening, and improves axial pull-out performance over previous generations of **TAPTITE**® fasteners.

---

## Predictable Failure Mode

Every manufacturer has struggled with the costly implications created when an overtightened fastener results in stripped nut members or castings. The resultant waste, repair, and related downtime is often an unrecoverable cost.

**TAPTITE PRO**® thread-forming fasteners feature a predictable failure mode that eliminates stripping issues. When properly used in standard lengths of engagement, overtightened **TAPTITE PRO**® fasteners will fracture within the screw threads. Rather than replacing or repairing costly nut members or castings, an overtightened joint will now consistently result in a broken fastener that can quickly be removed with a screw extractor. This design improvement was accomplished without sacrificing any tensile or torsional strength requirements.

---

## TRILOBULAR® Cross Section

Like all screws in the family, **TAPTITE PRO**® thread-forming fasteners feature the distinctive **TRILOBULAR**® cross-section. These screws deliver the same superior vibration resistance, low thread-forming torque, high prevailing torque, and cross-threading elimination that have made **TAPTITE**® fasteners famous for generations.

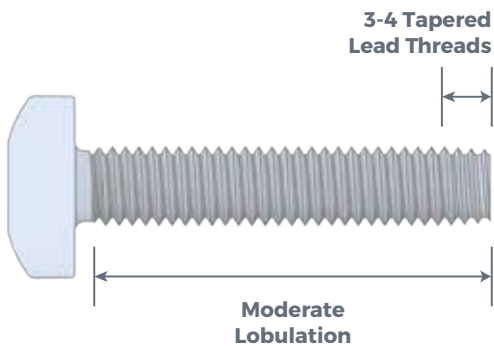
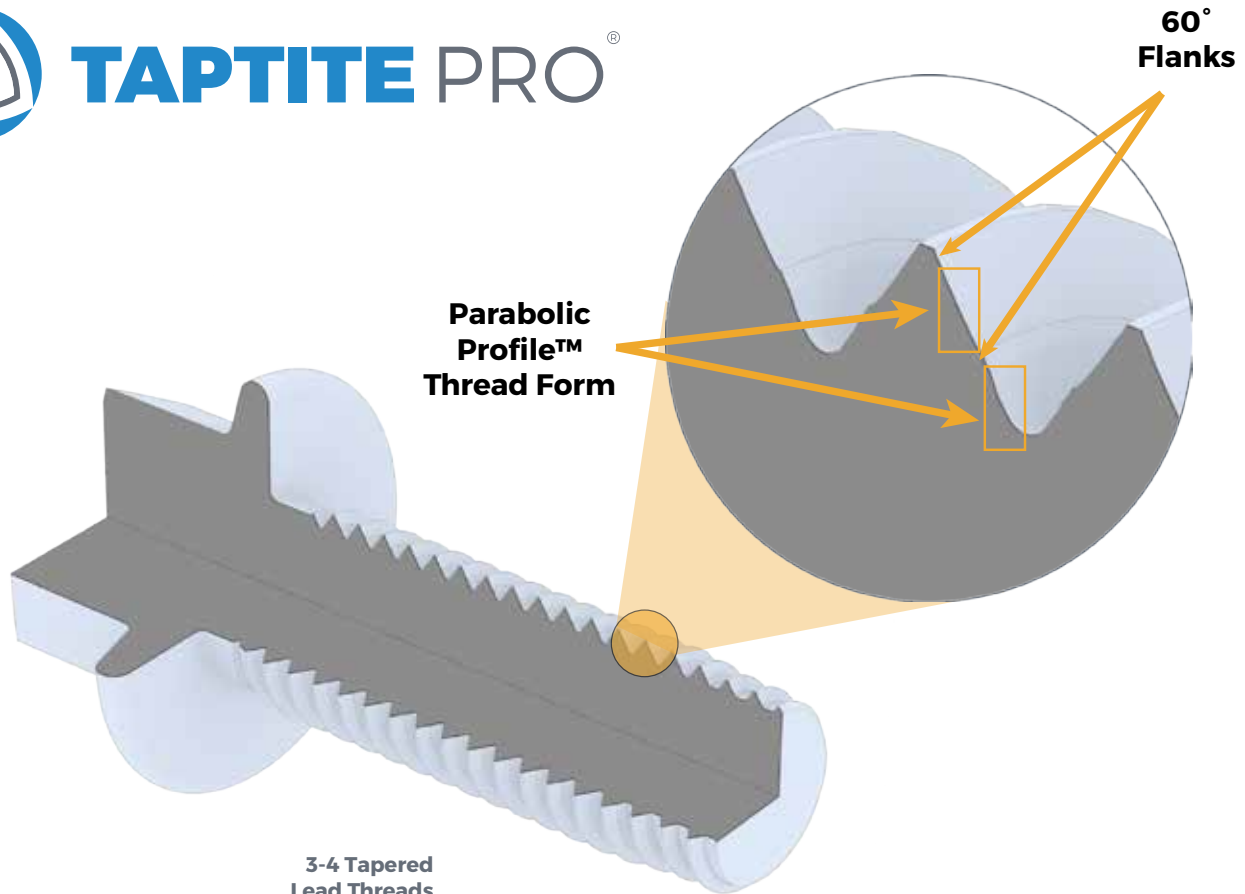

#### TAPTITE PRO® (M5 or #12 and smaller)

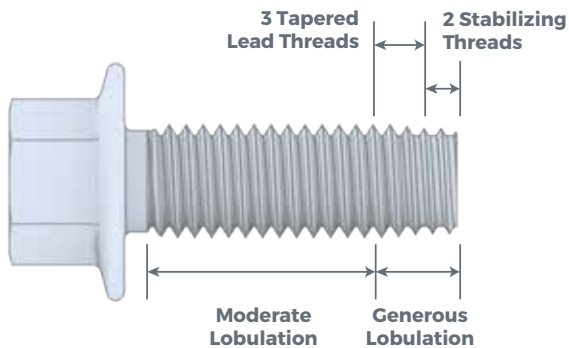

#### TAPTITE PRO® (M6 or 1/4" and larger)

### TAPTITE PRO® Thread-forming Fasteners

TAPTITE PRO® thread-forming fasteners – the most advanced products in the TAPTITE® family of fasteners.

These pages outline the options available in the TAPTITE PRO® product range. Each TAPTITE PRO® fastener:

#### Eliminates

- Failure mode of stripping in standard depths of engagement

#### Maintains

- Axial alignment
- Low end load
- Low thread-forming torque
- Efficient torque-tension relationships
- Resistance to vibrational loosening
- Resistance to axial pull-out



# TAPTITE PRO<sup>®</sup> SP<sup>™</sup>

2 - 2.5 Tapered Lead Threads



Moderate Lobulation

TAPTITE PRO<sup>®</sup> SP<sup>™</sup> fasteners are the short point (SP) version of the TAPTITE PRO<sup>®</sup> fastener, designed to accommodate limited clearance applications like aluminum cored holes.

The TAPTITE PRO<sup>®</sup> SP<sup>™</sup> fastener carries a **single consistent out-of-round with moderate lobulation**. The point of the TAPTITE PRO<sup>®</sup> SP<sup>™</sup> fastener is a shorter, 2 - 2 1/2 point tapered lead thread design.

The end result maximizes thread engagement without the added cost of increased core pin length.

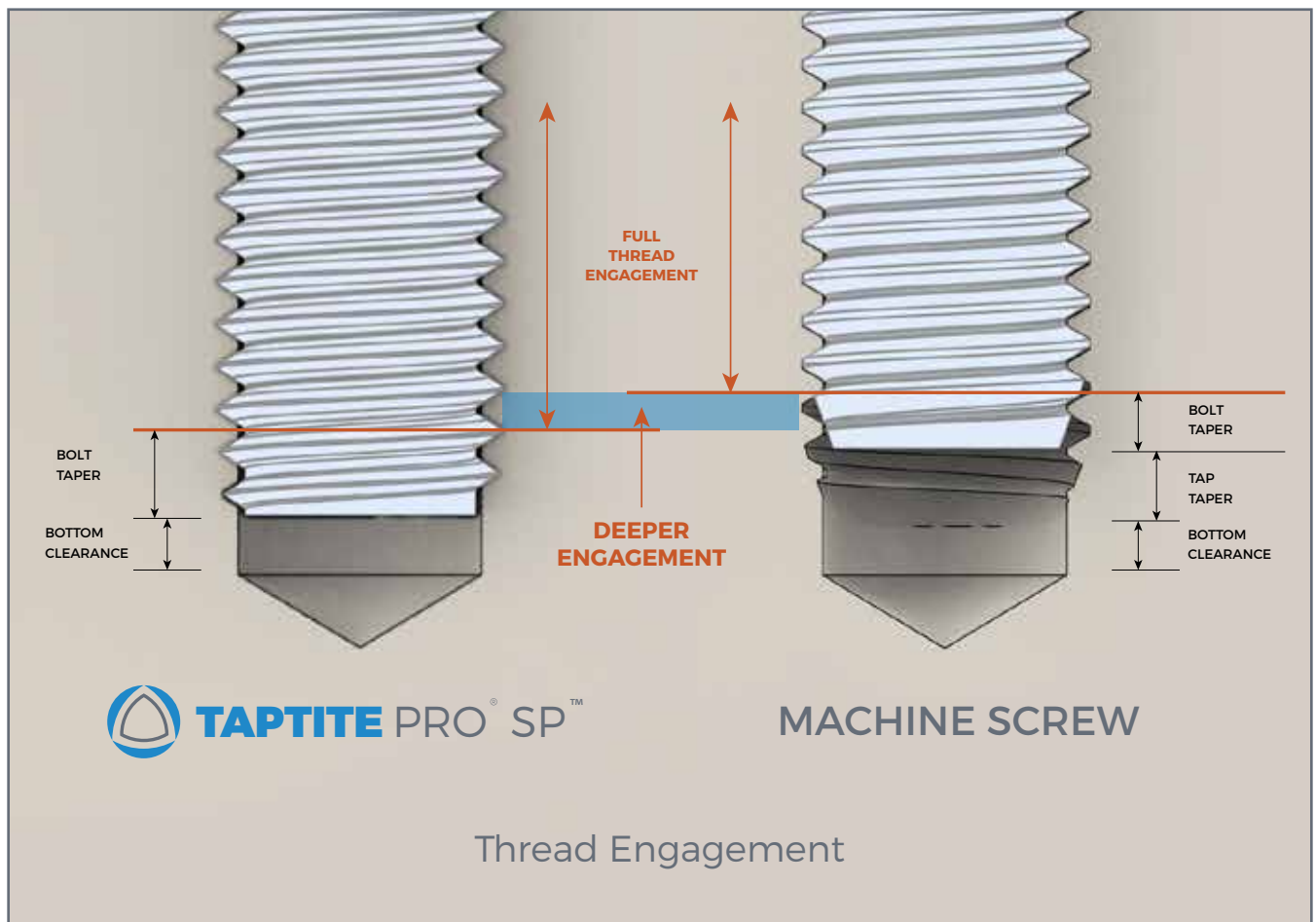

Thread Engagement

## TAPTITE PRO<sup>®</sup> CA<sup>™</sup>



The **TAPTITE PRO<sup>®</sup> CA<sup>™</sup>** fastener features a CA point that is ideal for rapid hole finding, floating nut members or difficult access applications.

The CA point can be supplied with a sharp point or a slightly truncated blunt point, desirable for situations when the sharp point could be a potential hazard to wires, components or assembly line and service personnel.

## TAPTITE PRO<sup>®</sup> NST<sup>™</sup>

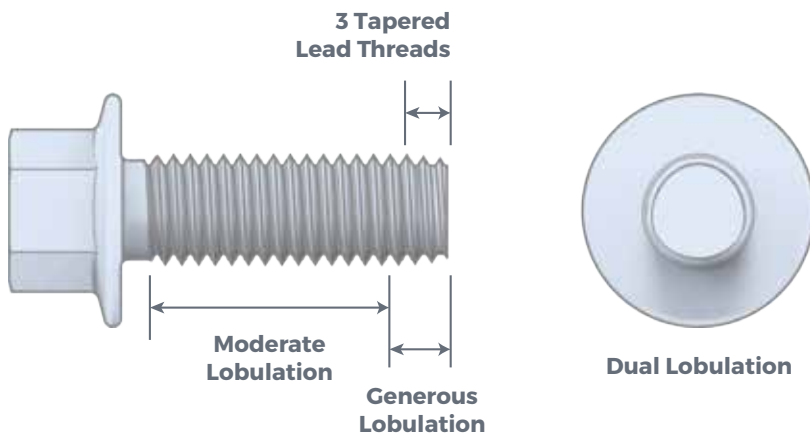

**TAPTITE PRO<sup>®</sup> NST<sup>™</sup>** fasteners have no stabilizing threads, for applications with limited packaging conditions. **Dual lobulation is maintained** as in the original TAPTITE PRO<sup>®</sup> fastener.

**TAPTITE PRO<sup>®</sup> NST<sup>™</sup>** is available in M6 (1/4") or larger sizes.

## Fastener Heat Treatment Options

### CORFLEX<sup>®</sup> I<sup>™</sup> Heat Treatment

CORFLEX<sup>®</sup> I<sup>™</sup> TAPTITE PRO<sup>®</sup> fasteners are neutral hardened to property class 8.8, 9.8, 10.9 or any intermediate value. The thread-forming zone is selectively induction hardened in order to form threads in steel untapped nuts.

CORFLEX<sup>®</sup> I<sup>™</sup> heat treatment allows TAPTITE PRO<sup>®</sup> thread-rolling fasteners to provide in-place cost savings in large structural applications with strength, ductility and toughness equal to grade strength machine screws or bolts.

### CORFLEX<sup>®</sup> N<sup>™</sup> Heat Treatment

CORFLEX<sup>®</sup> N<sup>™</sup> TAPTITE PRO<sup>®</sup> fasteners are neutral hardened to property class 8.8, 9.8, and 10.9 strength level. CORFLEX<sup>®</sup> N<sup>™</sup> heat treatment can be specified for any size TAPTITE PRO<sup>®</sup> or TAPTITE PRO<sup>®</sup> SP<sup>™</sup> fasteners intended to be used in aluminum, magnesium or zinc alloys.

### Case Hardening

Case hardening is the standard heat treatment for TAPTITE PRO<sup>®</sup> screws in sizes M5 (#12) and smaller in steel nut members.



## TAPTITE PRO® & TAPTITE PRO® SP™ Screw Body Dimensions

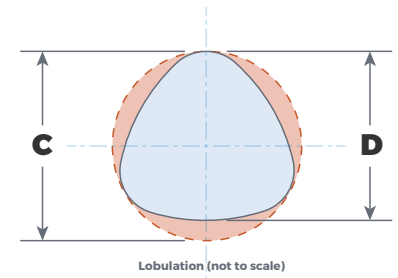

### Metric Sizes (mm)

Screw Size	C <sub>max</sub>	C <sub>min</sub>	D <sub>max</sub>	D <sub>min</sub>
M1.0 x 0.25	1.000	0.955	0.975	0.924
M1.2 x 0.25	1.200	1.155	1.175	1.124
M1.4 x 0.30	1.405	1.355	1.375	1.317
M1.6 x 0.35	1.61	1.53	1.58	1.49
M1.8 x 0.35	1.81	1.73	1.78	1.69
M2.0 x 0.40	2.01	1.93	1.97	1.88
M2.2 x 0.45	2.21	2.12	2.17	2.06
M2.5 x 0.45	2.52	2.43	2.48	2.37
M3.0 x 0.50	3.02	2.93	2.97	2.87
M3.5 x 0.60	3.52	3.42	3.46	3.35
M4.0 x 0.70	4.02	3.92	3.95	3.83
M4.5 x 0.75	4.52	4.41	4.45	4.32
M5.0 x 0.80	5.02	4.91	4.94	4.81
M6.0 x 1.00	6.10	5.97	6.00	5.85
M7.0 x 1.00	7.10	6.97	7.00	6.85
M8.0 x 1.25	8.13	7.97	8.00	7.81
M9.0 x 1.25	9.13	8.97	9.00	8.81
M10 x 1.50	10.15	9.97	10.00	9.78
M12 x 1.75	12.18	11.97	12.00	11.75
M14 x 2.00	14.20	13.97	14.00	13.72
M16 x 2.00	16.20	15.97	16.00	15.72
M18 x 2.50	18.25	17.97	18.00	17.66
M20 x 2.50	20.25	19.97	20.00	19.66

### Inch Sizes (in)

Screw Size	C <sub>max</sub>	C <sub>min</sub>	D <sub>max</sub>	D <sub>min</sub>
0 - 80	0.0626	0.0586	0.0613	0.0570
2 - 56	0.0880	0.0840	0.0862	0.0818
3 - 48	0.1010	0.0970	0.0989	0.0944
4 - 40	0.1138	0.1098	0.1113	0.1067
5 - 40	0.1268	0.1228	0.1243	0.1197
6 - 32	0.1413	0.1353	0.1382	0.1314
8 - 32	0.1674	0.1614	0.1643	0.1575
10 - 24	0.1934	0.1874	0.1892	0.1822
10 - 32	0.1936	0.1876	0.1905	0.1837
12 - 24	0.2194	0.2134	0.2152	0.2082
1/4 - 20	0.2550	0.2490	0.2500	0.2440
5/16 - 18	0.3180	0.3120	0.3125	0.3065
3/8 - 16	0.3810	0.3750	0.3745	0.3685
7/16 - 14	0.4445	0.4385	0.4375	0.4315
7/16 - 20	0.4425	0.4365	0.4375	0.4315
1/2 - 13	0.5075	0.5015	0.5000	0.4940
9/16 - 12	0.5710	0.5630	0.5625	0.5545
5/8 - 11	0.6340	0.6260	0.6250	0.6170



## FASTITE 2000<sup>®</sup>

THE SOLUTION FOR THIN SHEET METAL APPLICATIONS

Improvements in the assembly process have reduced the size and weight of components made from thin sheet metal and fasteners used to join these components. As a result, 0.5mm thick sheet metal is not an uncommon thickness for a typical assembly. Yet today's assembly solutions are limited and often poorly designed for both joint performance and overall cost efficiency.

**FASTITE 2000<sup>®</sup>** thread forming screws were developed to create strong mechanical joints with excellent thread engagement into untapped thin sheets, while providing the **lower in-place cost savings** associated with TRILOBULAR<sup>®</sup> thread-forming screws. FASTITE 2000<sup>®</sup> screws result in a cost-effective joint with increased failure torque and resistance to stripping, when compared to other fastener types and assemblies.



## FASTITE 2000® Performance Features

1. Tapered thread root adjacent to the screw head to maintain major thread diameter close to the head.
2. Undercut feature to increase assembly failure torque
3. Radius Profile™ thread design combined with the twin-lead helix angle to provide a mating thread system whereby diametrically opposed threads are engaged
4. Non cut-off “CA” style point for extruding in small holes
5. Optional feature of 24 serrations spaced 15° apart
6. TRILOBULAR® screw thread body to provide resistance to loosening

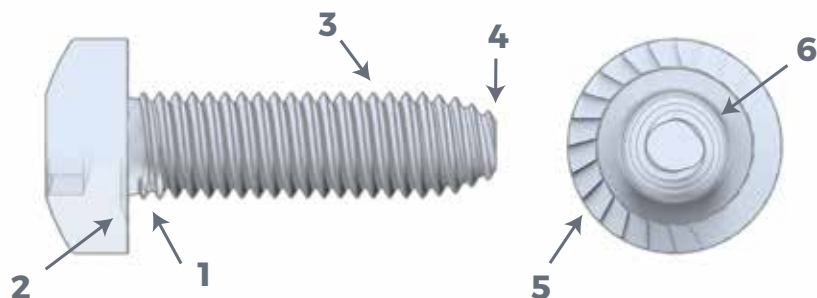

### A Better Screw for Sheet Metal Assembly

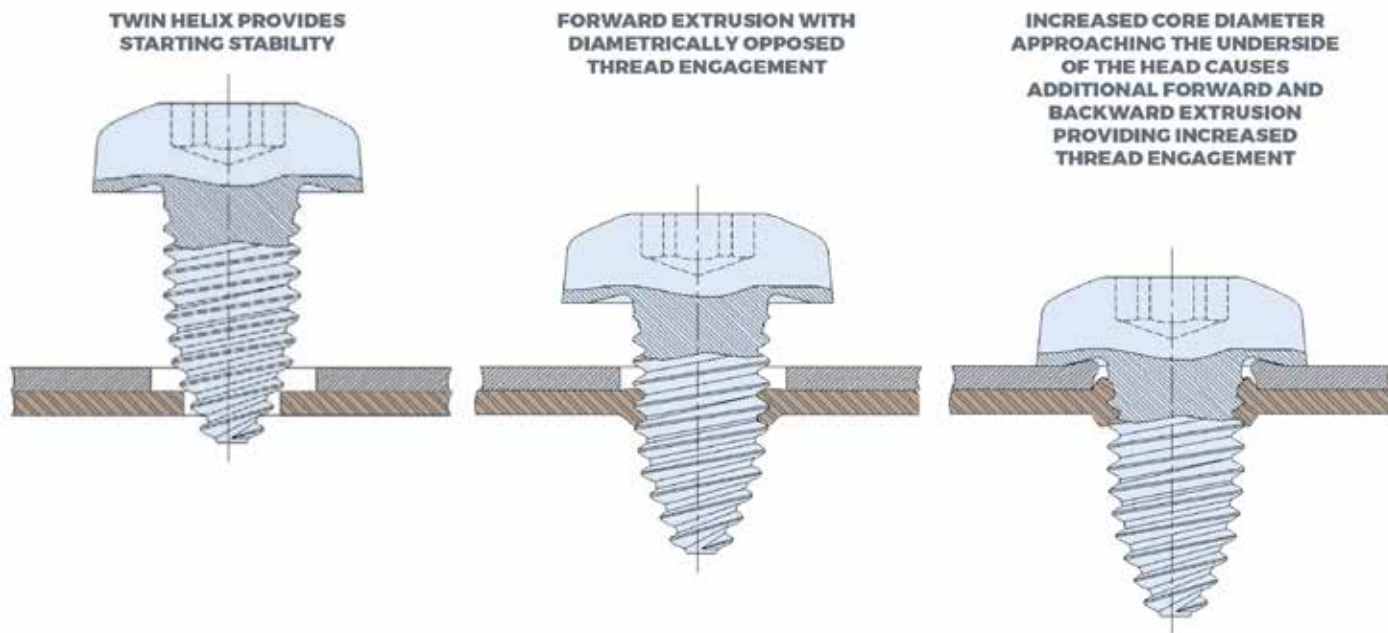

## Legacy TAPTITE® Fasteners

For over 50 years, **TAPTITE®** screws have been the clear choice for high performance thread-rolling fastener applications. During that time, many generations of TAPTITE® screws have been produced, with each enjoying commercial success in the marketplace. Each new design has refined the technology and improved the cost-savings potential of our product family.

Due to the remarkable performance and effectiveness of these various TAPTITE® designs, several generations of TAPTITE® designs are still regularly specified for use in company standards and requests.

These pages summarize the key features of some of our most popular fastener models.

For more technical information on these or other TAPTITE® fasteners, please contact our office or visit [taptite.com](http://taptite.com)

### TAPTITE 2000®

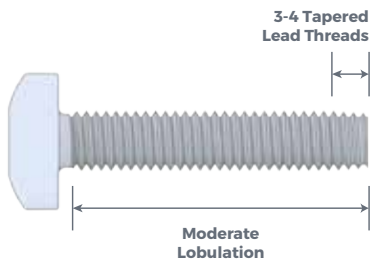

**TAPTITE 2000® (M5 or #12 and smaller)**

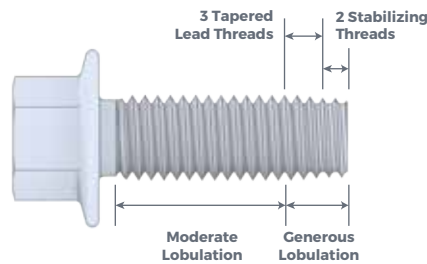

**TAPTITE 2000® (M6 or 1/4" and larger)**

**TAPTITE 2000®** thread-forming technology joined two unique concepts and advanced fastener performance to new levels.

Hitting the market in 1998, the TAPTITE 2000® family of fasteners introduced an innovative new thread design - the **Radius Profile™** thread. The proven **TRILOBULAR®** principle is maintained with a dual lobulation in the screw body, while incorporating the Radius Profile™ thread.

### TAPTITE 2000® SP™

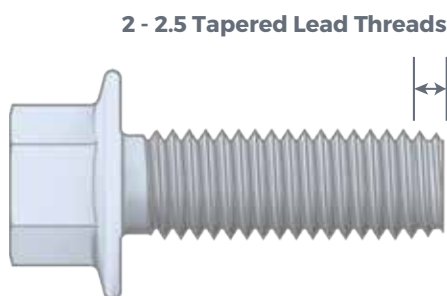

**Moderate Lobulation**

The **TAPTITE 2000® SP™** fastener is the short point (SP) version of the TAPTITE 2000® screw, designed to accommodate limited clearance applications.

The TAPTITE 2000® SP™ fastener carries a single consistent out-of-round with moderate lobulation. The point of the TAPTITE 2000® SP™ is a shorter, 2 - 2 1/2 point tapered lead thread design.

## TAPTITE 2000<sup>®</sup> CA<sup>™</sup>



The **TAPTITE 2000<sup>®</sup> CA<sup>™</sup>** fastener features a CA point that is ideal for rapid hole finding, floating nut members or difficult access applications.

The CA point can be supplied with a sharp point or a slightly truncated blunt point, desirable for situations when the sharp point could be a potential hazard to wires, components or assembly line and service personnel.

## DUO-TAPTITE<sup>®</sup>

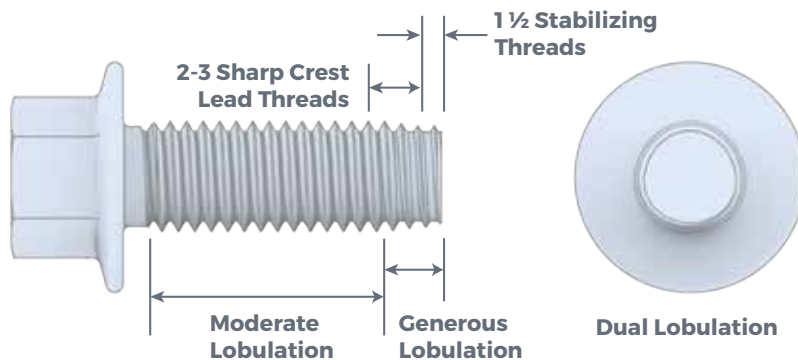

Introduced in 1979, the **DUO-TAPTITE<sup>®</sup>** fastener was the first fastener in the TAPTITE<sup>®</sup> family to feature **Dual Lobulation** - two distinct out-of-round profiles along the screw body.

DUO-TAPTITE<sup>®</sup> screws have generous lobulation at the screw point for easy entry and optimum thread-forming action plus reduced lobulation in the screw body holding area. A stabilizing threaded dog point ensures ready, aligned entry, with easy pick-up requiring minimal starting end load.

## TAPTITE II<sup>®</sup>

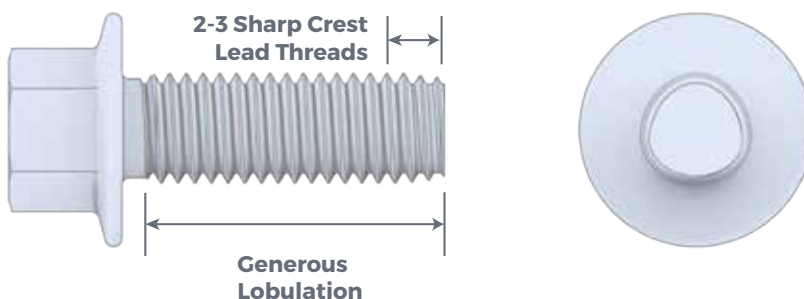

Introduced in 1990, the **TAPTITE II<sup>®</sup>** fastener improved upon the original TAPTITE<sup>®</sup> fastener design. With a more efficient manufacturing method and an improved tool design, TAPTITE II<sup>®</sup> screws produced an even more consistent product.

Torque performance was made more uniform, thread-forming torque was lowered, and the net result was a consistent part that integrated well with emerging SPC production philosophies.



## Breaking Down the Total Cost of Assembly

Consider the cost of a simple screw used in an assembly. The first instinct for cost savings is typically to find the cheapest fastener available.

However, the actual fastener makes up **only 15%** of overall assembly costs. The remaining **85% of cost** is comprised of hole preparation, tapping, cleaning, locking compound application, nut purchase, driving the screw, operator cost, etc. This considerable 85% portion of assembly cost represents the **Big 85™**. A fastening system that reduces the Big 85™ will lower assembly costs far more effectively than buying a cheaper fastener. The **TAPTITE®** family of thread-rolling fasteners has been reducing

the Big 85™ in automotive, white goods, lawn equipment and electronics for decades.

With a history of use from the 1964½ Ford Mustang to today's latest electric vehicles and electronic devices, **TAPTITE®** fasteners have achieved one constant result – **Maximum In-Place Cost Savings**.

**TAPTITE®** fasteners eliminate the costs of tapping, washers, locking compounds or even the use of a nut. Examine the costs in your own process, and consider the savings a **TAPTITE®** fastener can bring to your bottom line.

### Typical Fastener Installation

#### Components

- Labor
- Overhead
- Preparation of assembly
- Drilling and tapping the hole
- Application of locking device or adhesive
- Driving and tightening the screw

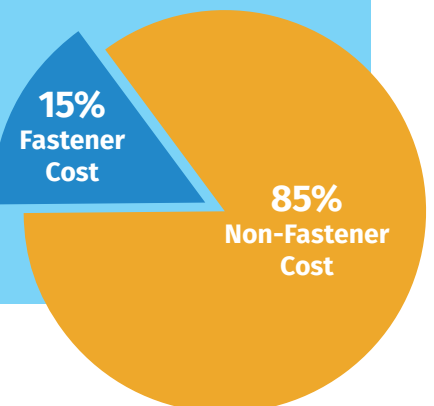



## Typical Costs: **Lighting Appliance**



- 3 Fastening Elements
- 2 Assembly Directions
- Complex Manual Assembly
- 2 Assembly Processes



- 1 Fastening Element
- 1 Assembly Direction
- Automated Assembly
- 1 Assembly Process

### Parts Breakdown: Standard Screw vs TAPTITE PRO® Screw Process

	Standard Screw (\$/100)	TAPTITE PRO® Screw (\$/100)
Screw M4 x 8	1.15	3.39
Clinching Process	9.07	—
Drill/Punch Pilot Hole	12.73	12.73
Clinch Nut	14.54	—
Lock Washer	0.87	—
Washer Assembly	3.64	—
<b>Total:</b>	<b>42.00</b>	<b>16.12</b>

**61% Savings**





# POWERLOK<sup>®</sup>

## Thread-locking Fasteners

**POWERLOK<sup>®</sup>** thread-locking fasteners lower the cost of assembly through the elimination of parts and process steps, as well as through direct and indirect costs.

POWERLOK<sup>®</sup> screws provide exceptional resistance to vibrational loosening through the creation of physical interference in the root of the nut member. This interference eliminates the need for expensive physical and chemical locking solutions. Eliminating the use of chemical adhesives or patches simplifies processes and procurement and also reduces environmental impact.

The features and benefits of the POWERLOK<sup>®</sup> fastener are “rolled on” as the fastener is made in the heading and rolling process. This makes POWERLOK<sup>®</sup> thread-locking fasteners highly cost-effective compared to fastening solutions requiring secondary operations.

Most importantly, POWERLOK<sup>®</sup> fasteners provide superior performance to available alternatives in applications where resistance to vibrational loosening is mandatory, as well as in electrical grounding applications. POWERLOK<sup>®</sup> fasteners’ ability to lock without pre-tensioning also makes them an excellent choice as an adjusting and clamping screw.

POWERLOK<sup>®</sup> fasteners are used across a broad range of applications as a high-performance and cost-effective solution.



**POWERLOK® II™**

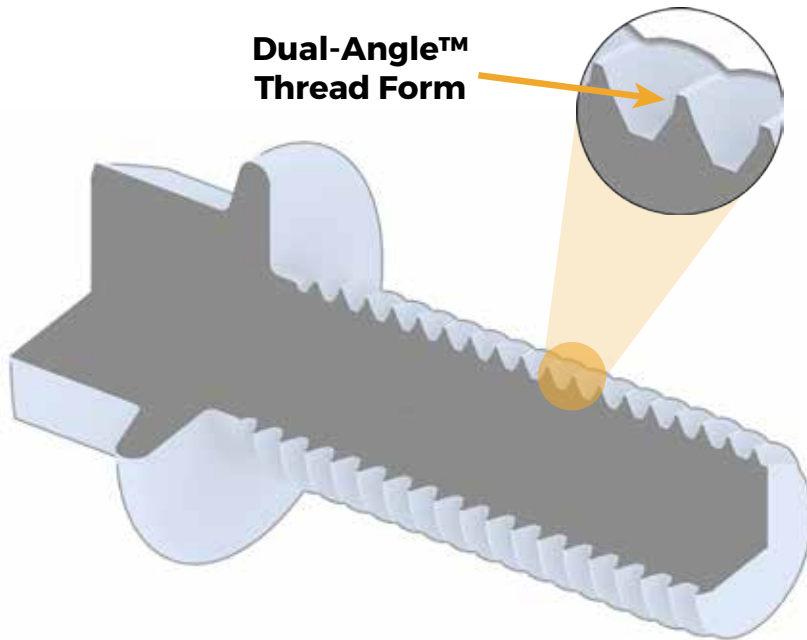

**Dual-Angle™  
Thread Form**



**Tapered  
Lead Threads**



**TRILOBULAR®  
Cross-Section**

## All Metal Locking Fasteners

**POWERLOK® II™** fasteners are the most advanced all metal locking screw on the market. Featuring a TRILOBULAR® cross-section and a patented Dual-Angle™ thread form, the screw is optimized to provide maximum resistance to vibration and mechanical loosening under a range of temperatures and environmental conditions where chemical adhesives and patches would fail.

### Features

- Improved, innovative Dual-Angle™ thread profile provides consistent, positive locking action
- Dual-Angle™ thread tip deflection also provides a spring-like stored energy locking
- Mechanically interferes in the root of the nut thread, and is unaffected by any incomplete internal thread-forming

### Benefits

- Eliminates need for patches, adhesives or assembly line applied locking compounds
- Does not require fastener seating to lock
- Locking action is ensured over the entire length of the screw thread
- Locking performance is unaffected by temperature
- No adhesive curing time—instantaneous locking action
- No need for under head locking elements
- No need for costly lock washers
- Works with all finishes
- Easily hand started







**POWERLOK®**

### Tapered Lead Threads

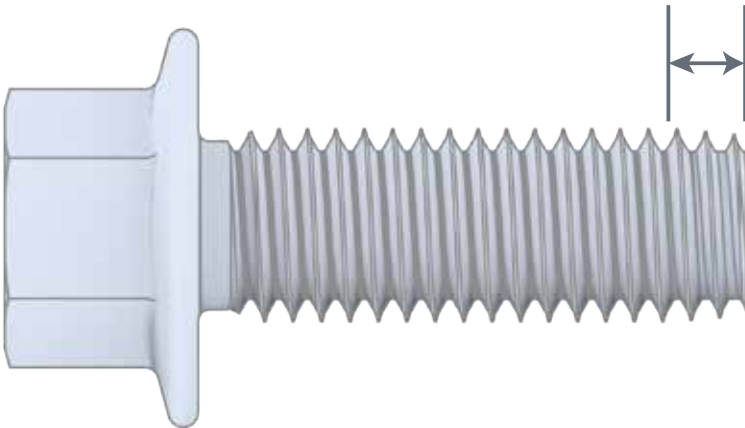

### TRILOBULAR® Cross-Section

## The Original TRILOBULAR® Locking Fastener

The first screw in the POWERLOK® family, the original **POWERLOK®** fastener paved the way for consistent mechanical interference locking in the nut member.

#### Features

- 60°-30° thread profile with enhanced locking ability
- Locking action developed at the outermost radius of the torque arm of the screw body

#### Benefits

- Eliminates need for patches, adhesives or assembly line applied locking compounds
- Locking action is insured over the entire length of the screw thread
- Locking action is unaffected by temperature
- No adhesive curing time—instantaneous locking action
- No need for under head locking elements.
- No need for costly lock washers
- Works with all finishes
- Easily hand started





# REMFORM<sup>®</sup>

## Thread-forming Fasteners for Plastics and Light Alloys

**REMFORM<sup>®</sup>** fasteners help lower the cost of assembly in engineered plastic materials. By eliminating weight while providing the requisite fastening performance, REMFORM<sup>®</sup> fasteners create value for designers, manufacturers and end users.

**REMFORM<sup>®</sup>** fasteners combine a thread form that promotes efficient material flow during thread-forming while also creating exceptional resistance to pullout forces. REMFORM<sup>®</sup> fasteners' ability to create high quality internal threads while minimizing the risk of boss bursting in the assembly process makes them an excellent thread-forming fastener.

Users who standardize on **REMFORM<sup>®</sup>** fasteners for plastic and light alloy material applications find efficiencies in:

- Research and Development
- Fastener acquisition
- Logistics
- Manufacturing
- After-market sales and service

**REMFORM<sup>®</sup>** fasteners are used to assemble a broad range of products across a multitude of industries globally.

**REMFORM<sup>®</sup>** fasteners can be found in products including but not limited to cars, toys, furniture, cell phones, fitness equipment, printers, photocopiers, hedge trimmers and countless other products.

Autocraft is a licensed manufacturer.

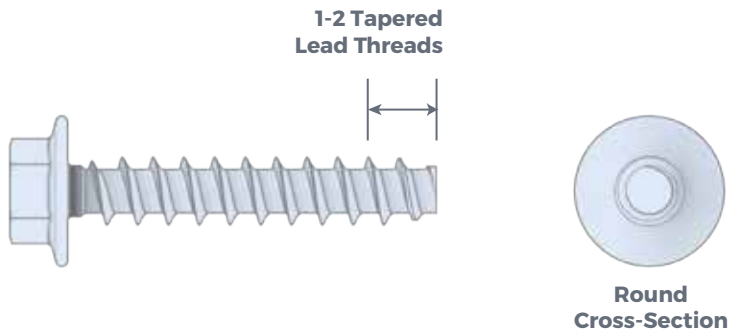
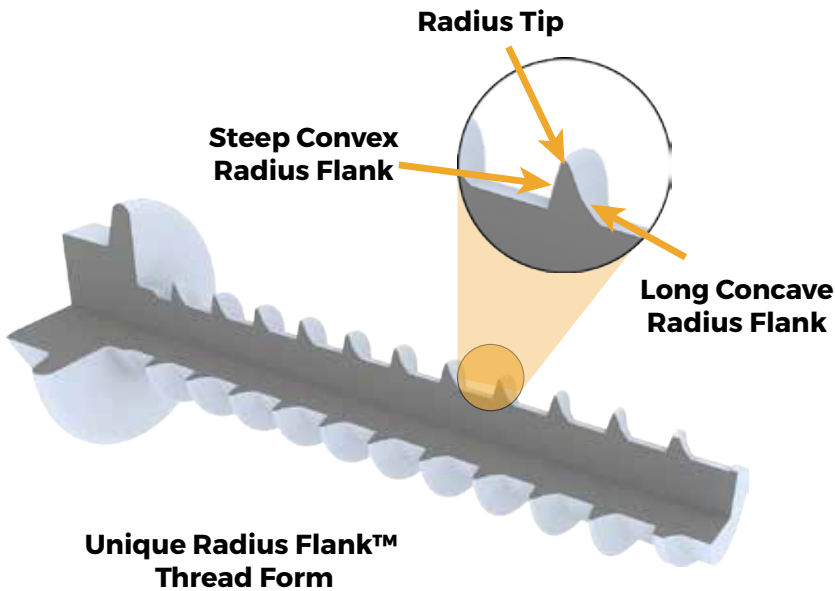

As designers attempt to reduce weight and improve the strength of products, engineered plastics become an increasingly prevalent material choice. **REMFORM® II™** fasteners are the solution for joining these materials.

The REMFORM® II™ screw is a thread-forming fastener with a unique thread form to provide superior performance in a wide range of engineered plastics. The asymmetrical thread minimizes radial hoop stress to reduce boss bursting. The narrow tip angle also reduces stress in the plastic nut member.

#### Reduced Hoop Stress

The radial tip thread crest of REMFORM® II™ screws reduces sharp corners, which reduces radial hoop stress in the plastic caused by thread-forming. When a threaded fastener is tightened, nearly all of the axial tightening load is opposed by the trailing or pressure flank of the screw and the mating thread flank of the internal thread. The steep pressure flank transfers most of the resultant tightening load in the axial direction, minimizing boss bursting tendencies created by the radial force. The axial force is over 4.5 times greater than the radial force.

#### The Unique Radius Flank™ Thread Form

REMFORM® II™ screws employ the **Unique Radius Flank™** asymmetrical thread form shown in the drawing to the left. The leading thread flank is most influential in forming the mating thread. The intercepting radius form on the leading flank is there to promote efficient material displacement and material flow. The pressure flank which opposes the fastener head is engineered to resist pull-out forces, whether they be applied by a tensile load or induced by torque. The steep pressure flank has a subtle radius designed to increase resistance to pullout and to efficiently develop tension. It also provides excellent material contact resulting in a high resistance to the internal threads stripping. In applications where the failure mode is fastener fracture, the high torsional strength of REMFORM® II™ fasteners ensures a high failure torque and improved resistance to loosening. This unique thread form and its narrow tip angle efficiently displace material and therefore require minimal energy to form an internal thread. The tip also utilizes a radius to better create the internal thread without increasing hoop stress in the plastic.

## REMFORM® II HS™

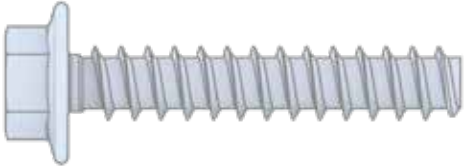

**REMFORM® II HS™** fasteners were developed to combine the features of REMFORM® II™ and REMFORM® II F™ fasteners with an optimized gap between the threads and core diameter. These optimizations allow a better flow of the mating plastic material and accept a higher amount of material between the flanks. This reduces overstressing of the plastic material during the assembly process.

The optimized core diameter provides a higher torsional strength, advantageous when the fastener is used in higher strength or fiber-reinforced materials. In applications with higher axial thread engagement, the optimized pitch allows more threads to be in contact with the plastic material.

The REMFORM® II HS™ fastener also uses the Unique Radius Flank™ asymmetrical thread design which is the standard for all REMFORM® fasteners.

## REMFORM® II F™



The **REMFORM® II F™** screw employs a finer pitch spacing to the efficient thread form of the standard REMFORM® II™ fastener, ideal for magnesium, soft aluminum, and other low ductility materials. The narrow tip angle minimizes the disturbance of a low ductility nut member.

## REMFORM®

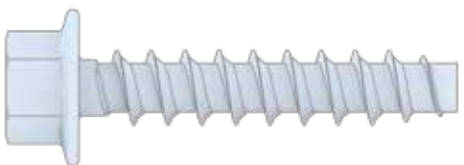

The original **REMFORM®** screw first featured the unique asymmetrical thread profile that minimizes radial hoop stress to reduce boss bursting. The narrow tip angle also reduces stress in the plastic nut member.

## Specialty Screws

While our TAPTITE®, POWERLOK®, and REMFORM® product families satisfy a vast majority of everyday assembly needs, our Engineering and R&D teams have also developed a variety of products to address specific fastening challenges.

The products in this section represent just a few selections from the extensive list of customized designs. If your project needs a specialized fastening solution, please contact us to discuss your specific situation.

### PLASTITE® 48-2™



**PLASTITE® 48-2™** TRILOBULAR® thread-rolling screws have twin-lead threads to provide faster, more efficient insertion in plastic materials. The sharp 48° thread profile increases holding strength and reduces material displacement and boss bursting tendencies. Drive and strip torques are higher, making drive tool adjustments simple.

The twin-lead thread design of the PLASTITE® 48-2™ fastener allows for much faster engagement than with single-lead screws.

### MAGTITE® 2000™



**MAGTITE® 2000™** screws are TRILOBULAR® thread-forming screws designed expressly for fastening magnesium die castings. Magnesium presents difficulties in the area of fastening, especially when using thread-forming fasteners.

MAGTITE® 2000™ screws have a TRILOBULAR® body configured to suit the low elasticity of magnesium, and a broad Radius Profile™ thread, which forms internal threads primarily by compressing the magnesium.

The compression action of the Radius Profile™ thread results in little to no debris generated during the thread-forming process in this friable material.

## PUSHTITE® II™



The **PUSHTITE® II™** fastener assembly process is accomplished by a simple press-in operation, reducing assembly time and simplifying serviceability. The PUSHTITE® II™ fastener's locking grooves are helical, allowing easy removal and reinsertion as necessary.

The helical thread form and TRILOBULAR® cross-section allow displaced air to escape during installation, minimizing the possibility of hydraulic boss bursting. The combination of the PUSHTITE® II™ fastener's 70°-10° semi-buttress thread shape and TRILOBULAR® thread form assures both easy entry and enormous pull-out resistance. In some plastics, this anti-pull-out strength increases with set time.

## KLEERLOK®



The **KLEERLOK®** feature is designed to be used in conjunction with TRILOBULAR® fasteners in pretapped holes which may be contaminated with weld splatter, paint, primer or other foreign matter.

The KLEERLOK® tip feature can be combined on a POWERLOK® screw for paint clearing and locking torque.

## KLEERTITE®



**KLEERTITE®** fasteners are a debris-clearing TRILOBULAR® screw for joints where a locking screw is not desired. Like their KLEERLOK® cousins, KLEERTITE® fasteners have the same ability to clear threads in pre-tapped holes contaminated with weld splatter, paint, primer or other foreign matter.

When configured as such, the KLEERTITE® fastener can be used in a pre-tapped hole with less prevailing torque than the KLEERLOK® fastener.





# Applications

The **TAPTITE®**, **POWERLOK®** and **REMFORM®** families of fasteners have added value to a diverse range of industries such as automotive, consumer products, electronics, and construction. No matter the fastening application, chances are that one of our products will be able to save assembly costs and provide enhanced performance to your application.

A brief list of popular applications of our fasteners includes:

## Automotive

- Seat belt anchor bolts
- Electrical grounding
- Underbody drivetrain support
- Truck bed attachment

## Consumer Products

- White goods appliances
- Plumbing fixtures
- Lawn & Garden tools
- Kitchen appliances

## Electronics

- Cellular phones & tablets
- Printers
- Telecommunications hardware
- Smart home devices

## Construction

- Curtain wall architectural facades
- Stadium seating
- Door hardware
- Heavy equipment & earth moving

Autocraft is a licensed manufacturer.

# Electrical Grounding Performance



Maintaining voltage consistency is vitally important for electrical grounding applications in any industry, and our thread-forming and thread-locking fasteners have set the performance benchmark in grounding applications over the years.

In 2020 licenser contracted Element Materials Technology, an A2LA-certified independent testing lab in Warren, MI to evaluate the electrical grounding performance of **TAPTITE PRO®** thread-forming fasteners and **POWERLOK® II™** mechanical thread-locking fasteners against that of a conventional machine screw. The testing was performed as prescribed by SAE International in their Test Procedure for Electrical Ground Attachment specification also known as SAE / USCAR-26.

The test compared the performance of 20 TAPTITE PRO® thread-forming fasteners in untapped steel weld nuts, 20 POWERLOK® II™ thread-locking fasteners in tapped weld nuts and 18 machine screws in tapped weld nuts (two machine screw sample terminals were damaged during setup and eliminated from the test). All nuts were E-coated, as consistent with common automotive practices.

The results, summarized at right, reveal that TAPTITE PRO® thread-forming fasteners and POWERLOK® II™ mechanical thread-locking fasteners yielded **60% less voltage drop with 80% more consistency than conventional machine screws.**

In addition to their exceptional grounding performance, these fasteners also reduce product cost and weight by eliminating parts, processes and associated overhead as well as the energy required to produce, ship, process and install these unneeded solutions.

Voltage Loss: TAPTITE PRO®, POWERLOK® II™, vs. Machine Screw

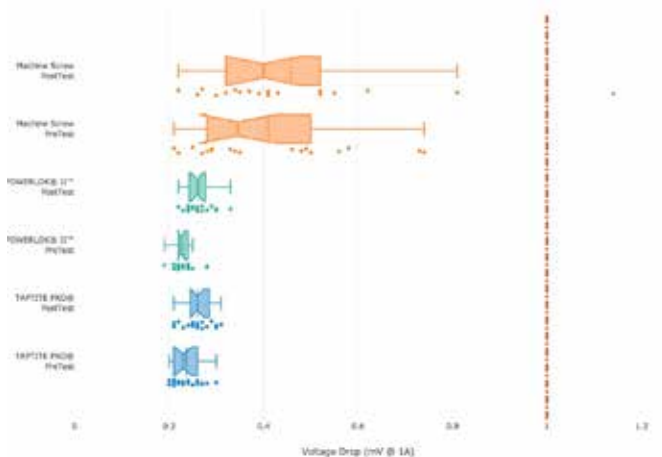

## Threadforming in Light Alloy Castings

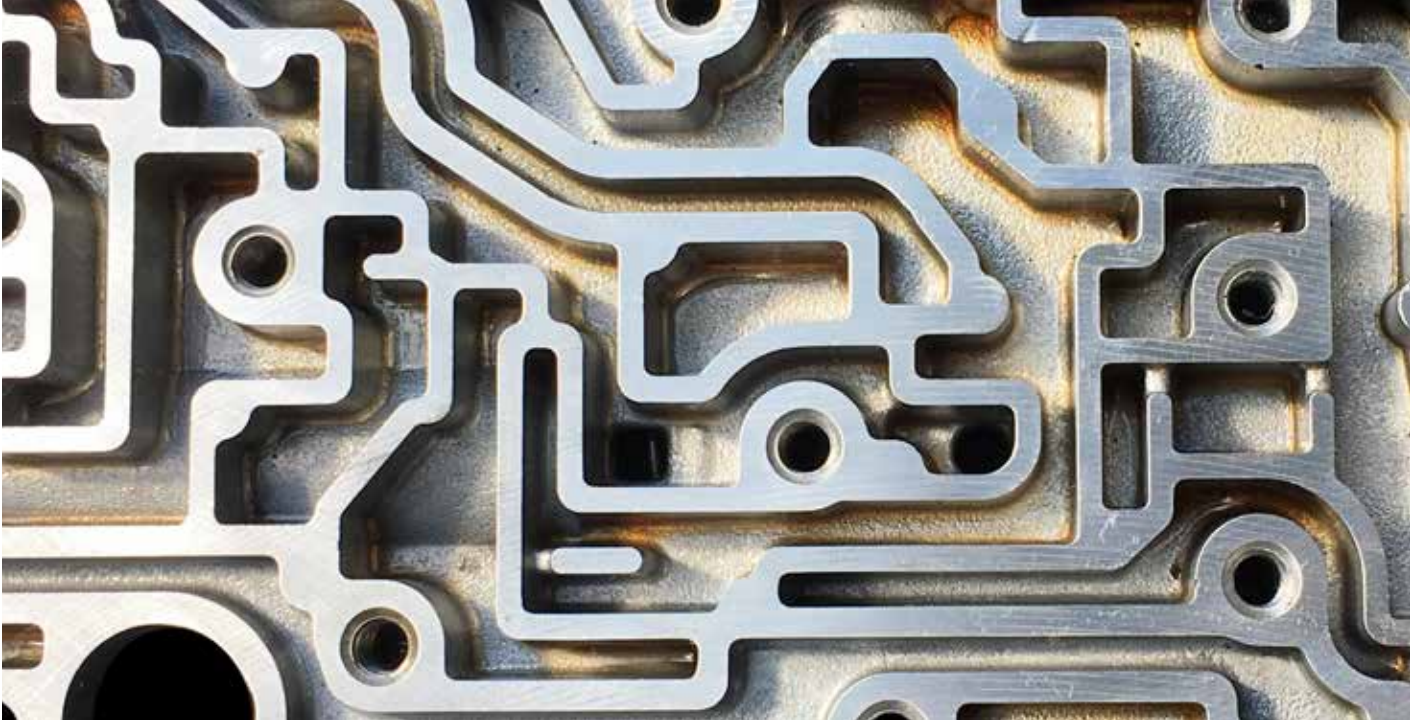

Soft alloys are the defining material for the lightweight, energy efficient transportation vehicles of the future. Rapid advancements in modern alloy casting technology and a commitment by several EV automakers to aluminum as a material of choice underscore the importance and relevance of aluminum in modern assembly.

The licensor has long recognized the the cost-savings potential and manufacturing efficiencies that light alloys can deliver to automotive manufacturers. In March 2012, the United States Council for Automotive Research (USCAR) performed extensive testing of thread-forming fasteners driven into light alloy castings with pre-cored holes.

The report, titled : **USCAR FAS 1005 - Machining Elimination through Application of Thread Forming Fasteners in Net-Shaped Holes**, determined whether cost-savings in light alloy castings could be achieved as had been done for many years with thread-forming fasteners being driven into unthreaded steel nut members. The report concluded that this recommended thread-forming fastener application would generate significant cost-savings for automotive manufacturers.

The tests confirmed that drilling, reaming, tapping, gaging, cooling and cleaning operations could be eliminated while retaining clamp load values consistent with industry expectations for steel nuts and bolts. In summary, TAPTITE® thread-forming fasteners deliver:

- **\$.07-\$.09 cost savings per fastener driven**
- **Significant reduction in electrical energy required to power unnecessary machines**
- **Elimination of all lubrication fluids and solvent washes necessary to the drilling/tapping process**
- **A shorter length assembly line footprint**
- **Less capital investment in plant and equipment.**

The 2012 USCAR report concluded that if this application were universally adopted in North America, with its estimated car build of 16 million vehicles, approximately 500 fasteners per vehicle, and a savings of \$.08 average per fastener, the total net cost-savings would total **US\$640 million per year for automotive manufacturers**. This number would be even higher when calculated in today's dollars.

## The Electrical Grounding Standard



Ford Motor Company uses the newest design of **TAPTITE PRO®** fasteners, for electrical grounding applications in their range of vehicles.

The engineers at Ford recognize reliable electrical grounding as a key property for vehicle performance. As such, Ford's own manufacturing standard **WD957** specifies **only TAPTITE PRO® fasteners for use in electrical grounding applications.**

TAPTITE PRO® fasteners tap their own threads directly in the nut member when installed, and this feature is perfectly suited to grounding applications.

Since TAPTITE PRO® fasteners form their own threads, they inherently clear any debris, paint, or oxidation present in the hole prior to assembly. This insures a positive metal-to-metal contact even in painted or coated nut members. And clean contact is the key to insuring optimum electrical conductivity.

There is simply no better electrical grounding screw than a **TAPTITE PRO®** fastener.

Shanghai Autocraft holds lincensee certificate of these products.

## Architectural Curtain Wall



In the 2009 expansion of the San Francisco International Airport, architects and builders chose **TAPTITE®** fasteners for their thread-forming ability, providing a quick and cost effective solution to install attractive wall panels throughout the airport.

TAPTITE® fasteners are commonly used in these types of **architectural applications**, where facades of glass, steel, and other dissimilar materials are applied in front of the structural portion of a building.

Similar applications for TAPTITE® fasteners include the installation of **solar panel arrays**, **fenestration systems**, and related scenarios involving dissimilar materials and blind fastening challenges.

**Autocraft is a licensed manufacturer.**

## Hedge Trimmer



Without reliable vibration resistance, hedge trimmer blades will loosen over time and use. The cutting blades will separate and the trimmer will no longer cut efficiently. This exact problem led one leading manufacturer of garden tools to seek a more robust solution.

Their design team reworked the trimmer blade assembly to incorporate five **TAPTITE®** screws driven directly into pilot holes in the steel stationary bar of the trimmer. The inherent locking action of these thread-forming **TAPTITE®** screws eliminated the vibrational issues present in the old machine screw/nut design. The product now performed as expected over time, ensuring efficient cutting over the service life of the tool.

But the product benefits didn't stop there. In the improved design, the old crimped nut assembly was eliminated altogether. Since **TAPTITE®** screws form their own threads in the stationary retaining bar, they don't require a separate nut. The customer realized simultaneous cost savings and performance gains.

## On-Board Electric Vehicle Charger



LG Chem offers complete component package solutions for automakers designing electric vehicles. The company not only produces batteries for electric cars, but also motors, inverters and now on-board chargers.

LG also knows the history of performance success and cost savings that **TAPTITE®** fasteners earned in internal combustion engine (ICE) vehicles, and is quickly adapting them into their EV components suite.

LG Chem's on-board EV charger is assembled using **TAPTITE®** fasteners, chosen not only for their thread-forming properties that eliminate cross-threading, but also for the inherent vibration resistance and cost savings they provide.

## Faucet Stem Assembly



A manufacturer of plumbing fixtures was using nylon patch Monel machine screws as bibb screws to assemble neoprene washers to brass faucet stems. These expensive nylon patch machine screws lost their locking torque after multiple cycling, requiring excess torque to tighten the neoprene washer to the faucet stem.

As a design solution, the manufacturer replaced the nylon patch machine screws with round head brass **POWERLOK®** screws. **POWERLOK®** screws retain their locking action through multiple cycles, exceeding IFI locking standards by as much as 400%. **POWERLOK®** screws also provide locking action over the entire length of the engaged shank. This immediately solved the locking issue on the faucet assembly.

As a side benefit, **POWERLOK®** fasteners eliminated the costly nylon patch application, saving considerable costs while improving product reliability.

## Consumer Electronics Devices



Computers, peripherals, cell phones and other electronic devices require a delicate combination of high performance and cost-savings. Contaminants produced by chips and dust generated by conventional drilling and tapping operations are not only costly, but can potentially ruin the performance of an electronic device.

Hewlett Packard is one manufacturer using both **TAPTITE®** and **REMFORM®** fasteners in the thin sheet metal and molded plastic components of Hewlett Packard chassis.

**TAPTITE®** and **REMFORM®** fasteners form their own threads and thereby eliminate any contaminants produced by any drilling and tapping operations. **TAPTITE®** and **REMFORM®** fasteners also eliminate cross-threading repairs and damaged components, saving significant costs and production time.

## Truck Bed Box Bolts



Ford Motor Co. had a manufacturing problem to solve. They had been installing conventional machine screws into pre-tapped floating nut members to secure the bed (pickup box) to the chassis of F-Series pickup trucks. Any misalignment between the floating nut and machine screw resulted in a costly cross-threading problem that cost time and new materials to fix.

The **TAPTITE®** “box bolt” was introduced at Ford Motor Co. in the mid 1990’s as the solution to this costly problem. By design, all **TAPTITE®** thread-rolling fasteners form their own mating internal thread upon installation, eliminating any chance of cross threading. An additional benefit to using **TAPTITE®** thread-forming technology is the cost savings realized in the elimination of the tapping operation altogether.

This **TAPTITE®** box-bolt example clearly demonstrates the problem solving and cost-savings benefits of **TAPTITE®** thread-rolling fasteners.





# A Global Licensee Network

Shanghai Autocraft is one of the licensees in 27 countries.

TAPTITE®, POWERLOK®, and REMFORM® fastener technology is readily available to all global manufacturing hubs.

These licensed manufacturers deliver an annual volume in excess of 17,000,000,000 pieces of TAPTITE®, POWERLOK®, and REMFORM® fasteners, comprising a mix of products.

## Technical Support

- New Product Research & Development
- Technical Reports
- Technical Manuals
- Engineering Consultation
- Computer Aided Design/Analysis
- Engineering Training
- Tooling Design/Procurement
- Manufacturing Consultation
- Collaborative Product Development
- Cost Reduction Analysis
- Metallurgical Analysis
- End-Use Application Guidance
- Technical Training Seminars

## Marketing & Communications Support

- Application Definition
- Application Reports
- Performance Documentation
- Sales Seminars
- Media Assets
- Product Brochures
- Joint Customer Visits
- Cooperative Studies
- Trademark and Patent Use

# 85%

Potential in-place cost savings

# 100+

Authorized Licensees Globally

# 27

Countries across the globe

# 17B

Fasteners produced each year



Shanghai Autocraft Co Ltd  
is a licensed manufacturer  
of the products in this doc.

